

**4M CMOS UV Camera**

**ID4MTVISB-CL**

**Technical Manual**

**iDule Corporation**

---

---

---

## Table of Contents

	PAGE
1. <b>Product Outline</b> .....	3
2. <b>Handling Precautions</b> .....	3
3. <b>Specification</b> .....	3
3.1. General Specification.....	3
3.2. Camera Output Signal Specification .....	5
3.3. Spectral Response (Representative Value).....	6
4. <b>Connector</b> .....	7
4.1. Camera Link Connector 12226-1100-00PL (3M) .....	7
4.2. Power LED .....	8
4.3. 12 PIN Connector HR10A-10R-12PB(72) (HIROSE) CN1 .....	8
5. <b>Timing Chart</b> .....	9
5.1. Horizontal Synchronous Signals Timing (4Tap Medium Configuration : STD Mode ).....	9
5.2. Vertical Synchronous Signals Timing (2Tap Base Configuration : STD Mode) .....	9
5.3. Horizontal Synchronous Signals Timing (4Tap Medium Configuration : HDR Mode) .....	10
5.4. Vertical Synchronous Signals Timing (4Tap Medium Configuration : HDR Mode) .....	10
5.5. Horizontal Synchronous Signals Timing (2Tap Base Configuration : STD Mode) .....	11
5.6. Vertical Synchronous Signals Timing (2Tap Base Configuration : STD Mode) .....	11
5.7. Horizontal Synchronous Signals Timing (2Tap Base Configuration : HDR Mode) .....	12
5.8. Vertical Synchronous Signals Timing (2Tap Base Configuration : HDR Mode).....	12
5.9. Video Output Format.....	13
5.10. Fixed Trigger Shutter Mode .....	15
5.11. Pulse Width Trigger Shutter Mode .....	16
6. <b>Partial Scan Mode</b> .....	17
7. <b>Remote Communication</b> .....	19
8.1. Command Specifications.....	20
8.2. Control Example .....	24
8. <b>Function Setting</b> .....	28
9. <b>Dimensions</b> .....	31
10. <b>Initial Setting</b> .....	32
11. <b>Cases for Indemnity (Limited Warranty)</b> .....	33
12. <b>CMOS Pixel Defect</b> .....	33
13. <b>Product Support</b> .....	33

---

---

## 1. Product Outline

ID4MTVISB-CL is a Camera Link interfaced and 4M resolution camera module. 4M pixels CMOS sensor with diagonal length 31.859mm is utilized. Entire pixels can be read out within 1/54s at Medium Configuration output.

### Features

- Rolling Shutter CMOS sensor is utilized.
- Camera Link Base , Medium Configuration are supported.
- Fixed trigger shutter mode, pulse width trigger shutter mode are operable.
- Full frame rates are as follows.

2Tap Base Configuration	27.1fps (STD Mode Low/High Gain) / 13.6fps (HDR Mode)	8/10/12bit
4Tap Medium Configuration*	54.2fps (STD Mode Low/High Gain) / 27.1fps (HDR Mode)	8/10/12bit

## 2. Handling Precautions

The camera must not be used for any nuclear equipment or aerospace equipment with which mechanical failure or malfunction could result in serious bodily injury or loss of human life. Our warranty does not apply to damages or defects caused by irregular and /or abnormal use of the product.

Please observe all warnings and cautions stated below.

Our warranty does not apply to damages or malfunctions caused by neglecting these precautions.

Do not use or store the camera in the following extreme conditions :

- Extremely dusty or humid places.
  - Extremely hot or cold places (operating temperature -5°C to +45°C).
  - Close to generators of powerful electromagnetic radiation such as radio or TV transmitters.
  - Places subject to fluorescent light reflections.
  - Places subject to unstable (flickering, etc.) lighting conditions.
  - Places subject to strong vibration.
- 
- Remove dust or dirt on the surface of the lens with a blower.
  - Do not apply excessive force or static electricity that could damage the camera.
  - Do not shoot direct images that are extremely bright (e.g., light source, sun, etc.), and when camera is not in use, put the lens cap on.
  - Confirm the mutual ground potential carefully and then connect the camera to monitors or computers. AC leaks from the connected devices may cause damages or destroy the camera.
  - Do not apply excessive voltage. (Use only the specified voltage.) Unstable or improper power supply voltage may cause damages or malfunction of the camera.
  - The voltage ripple of camera power DC +12V±10% shall be within ±50mV. Improper power supply voltage may cause noises on the video signals.
  - The rising time of camera power supply voltage shall be less than +10V, Max 60ms. Please avoid noises like chattering when rising.

## 3. Specification

### 3.1. General Specification

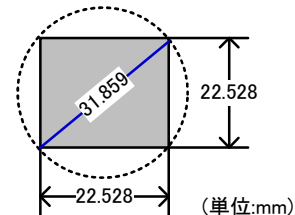
(1) Image Sensor	Type	Diagonal length 31.859mm, Rolling Shutter (Gpixel GSENSE400BSI)	
	Effective Pixel Number	2048(H) x 2048(V)	
	Cell Size	11 $\mu$ m(H) x 11 $\mu$ m(V)	
	Image Circle	$\Phi$ 31.859mm	
			
(2) Video Output Frequency	Pixel Clock	60MHz	
	Output Effective Pixel number	2048(H) x 2048(V) (STD/HDR Mode)	
	2Tap Base Configuration	27.1fps(STD) 13.6fps(HDR)	1080(H) x 2050(V) with Blanking 2160(H) x 2050(V) with Blanking
	4Tap Medium Configuration	54.2fps(STD) 27.1fps(HDR)	540(H) x 2050(V) with Blanking 1080(H) x 2050(V) with Blanking
(3) Video Output	2Tap Base Configuration		
	4Tap Medium Configuration		
(4) Output Format	Sensor AD	12bit	
	Camera Link	STD Mode (Low/High Gain) / HDR Mode 8/10/12 bit	
(5) Sensitivity	B/W	F16	2000lx (at shutter speed 1/54.2s, Gain 0dB, Medium Configuration STD mode)
(6) Power Requirements	DC+12 $\pm$ 10% PoCL		
(7) Power Consumption	typ 3.6W (at 4Tap Medium Configuration STD Mode Low Gain)		

(8) Dimensions	H:70mm W:70mm D:44mm excluding projection	
(9) Weight	Approx. 290g	
(10) Lens Mount	M42 (P:1.0) Mount	
(11) Gain Variable Range	0dB ~ +24dB (Guaranteed range)	
(12) Shutter Speed Variable Range	2Tap Base Configuration	STD Mode : OFF(1/27.1s) ~ 1/22000s HDR Mode : OFF(1/13.6s) ~ 1/22000s
	4Tap Medium Configuration	STD Mode : OFF(1/54.2s) ~ 1/32000s HDR Mode : OFF(1/27.1s) ~ 1/38000s
(13) Trigger Shutter Mode	Fixed Trigger Shutter Mode, Pulse Width Shutter Trigger Mode	
(14) Partial Scan	B/W Full Frame ~ 2Line (2Line/step)	
(15) Safety/Quality Standards	UL : Conform to UL Standard including materials and others.	
	CE : To be applied for EN55022:2006 Class B for Emission 06 To be applied for EN61000-6-2:2005 for Immunity	
	RoHS : Conform to RoHS	
(16) Durability	Vibration 20~200 Hz, 98m/s <sup>2</sup> (10G), X,Y and Z directions (120 min for each direction)	
	Shock No malfunction shall be occurred with 980m/s <sup>2</sup> (100G) for ±X,±Y,±Z, 6 directions. (without package)	
(17) Operation Environment	Temperature -5 ~ +45°C Humidity 20 ~ 80%RH with no condensation.	
(18) Storage Environment	Temperature -25 ~ +60°C Humidity 20 ~ 80%RH with no condensation.	

### 3.2. Camera Output Signal Specification

(1)Video Output Data	Effective Video Output	STD Mode : 2048(H) × 2048(V) HDR Mode : 4096(H) × 2048(V)	(at Full Frame Scan Mode)
(2)Sync Signal Output	LVAL FVAL DVAL	Camera Link (LVDS)	
(3)Camera Control Signal Input	CC2·CC3·CC4	Camera Link (LVDS)	
(4)Trigger Input	Polarity	Positive/Negative Selectable (Address 05)	
	Pulse Width	1HD(Min) ~ Approx.2 frames ·2Tap Base Configuration : 1HD (42.443us) ·4Tap Medium Configuration : 1HD (21.443us) Functionally, no upper limitation is set but noises such as dark noises and shadings might be noticeable at long time exposure.	
	12 pin Connector	12pin connector 11pin input (5V TTL)	
	CC1(Trigger Input)	Camera Link (LVDS)	
(5)Serial Communication	SerTC (Serial to Camera) SerTFG (Serial to Frame Grabber)	Camera Link (LVDS)	
(6)Video Signals	White Clip Level	FFh	(at Gain 0dB, 8bit)
	Setup Level	under 02h	
	Dark Shading	Both horizontal and vertical should be under 02Fh	

3.3. Spectral Response (Representative Value)

GSENSE 400BSI

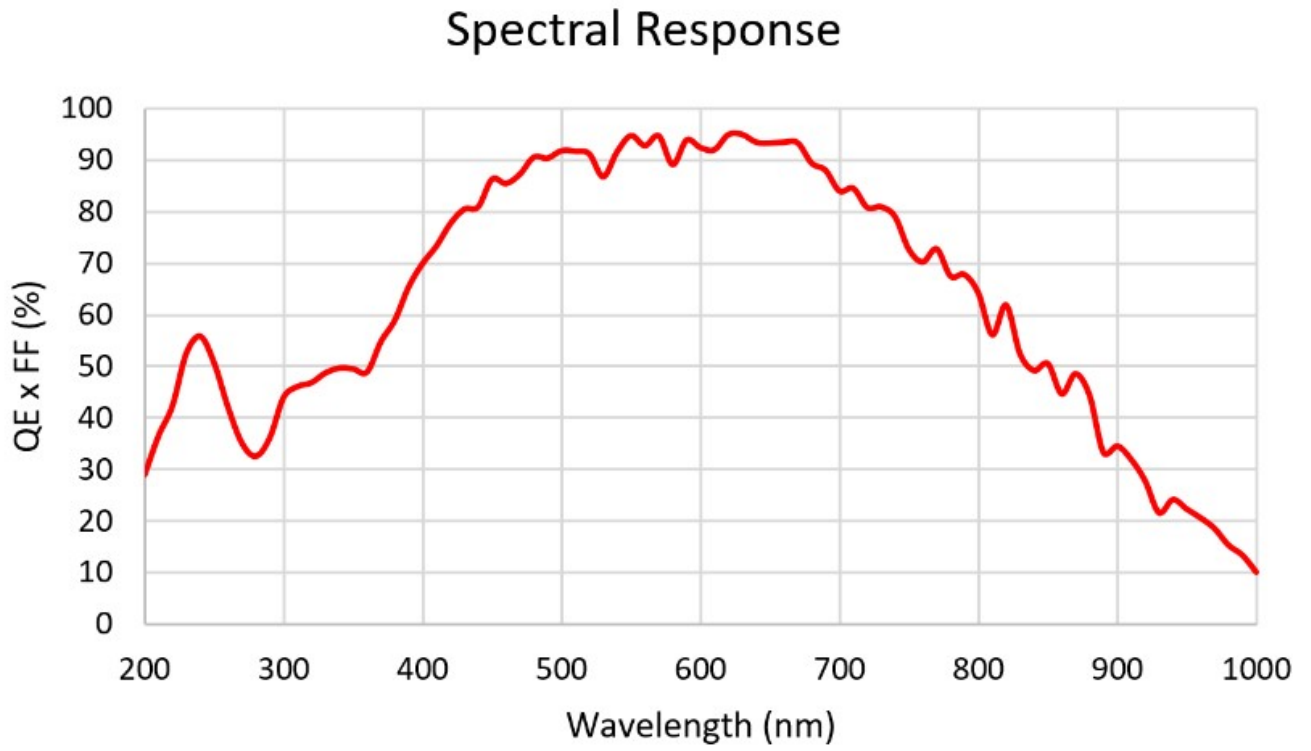

#### 4. Connector

##### 4.1. Camera Link Connector 12226-1100-00PL (3M)

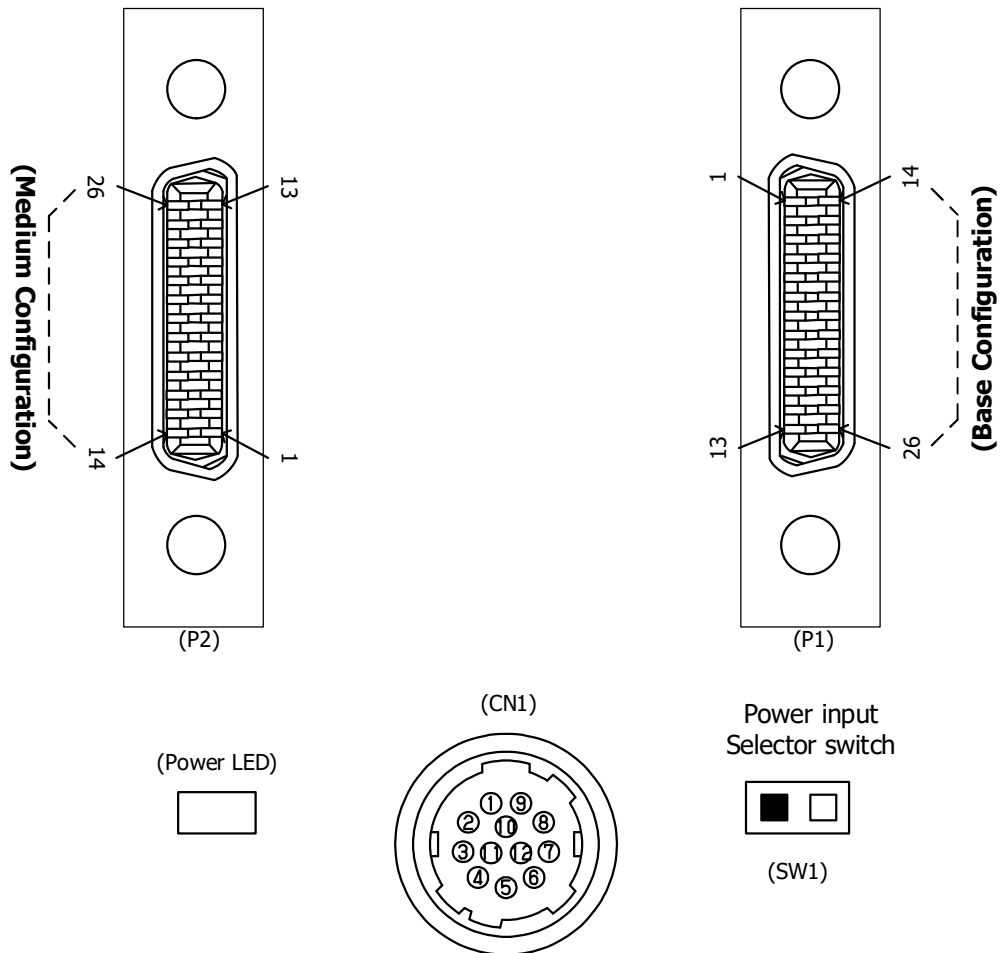

Connector (CN2)

Pin No		Pin No	
1	<b>NC</b>	14	<b>GND</b>
2	Y0-	15	Y0+
3	Y1-	16	Y1+
4	Y2-	17	Y2+
5	Yclk-	18	Yclk+
6	Y3-	19	Y3+
7	100Ω	20	Terminated
8	Z0-	21	Z0+
9	Z1-	22	Z1+
10	Z2-	23	Z2+
11	Zclk-	24	Zclk+
12	Z3-	25	Z3+
13	<b>GND</b>	26	<b>NC</b>

Connector (CN1)

Pin No		Pin No	
1	<b>+12V(PoCL)</b>	14	<b>GND</b>
2	X0-	15	X0+
3	X1-	16	X1+
4	X2-	17	X2+
5	Xclk-	18	Xclk+
6	X3-	19	X3+
7	SerTC+	20	SerTC-
8	SerTFG-	21	SerTFG+
9	CC1- (Trigger IN -)	22	CC1+ (Trigger IN +)
10	CC2+	23	CC2-
11	CC3-	24	CC3+
12	CC4+	25	CC4-
13	<b>GND</b>	26	<b>+12V(PoCL)</b>

#### 4.2. Power LED

Camera turns on LED light, when it is supplied electricity from the frame Grabber board.

#### 4.3. 12 PIN Connector HR10A-10R-12PB(72) (HIROSE) CN1

PIN NO	NAME	IO(5V TTL)	
1	GND		<p>(CN1)</p>
2	Power in (DC+12V)		
3	GND		
4	NC		
5	GND		
6	FVAL out		
7	NC		
8	GND		
9	NC		
10	Exposure out		
11	Trigger in		
12	GND		

#### 4.4. Power input Select

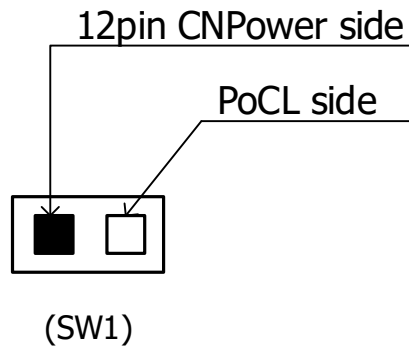



## 5. Timing Chart

### 5.1. Horizontal Synchronous Signals Timing (4Tap Medium Configuration : STD Mode)

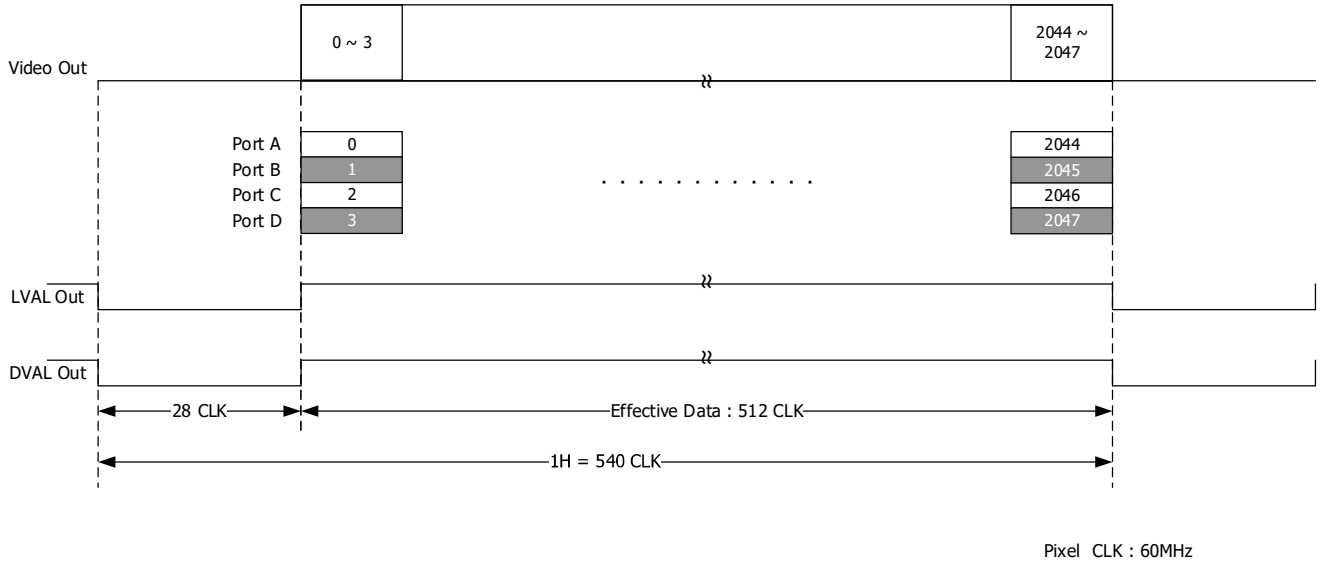

### 5.2. Vertical Synchronous Signals Timing (4Tap Medium Configuration : STD Mode)

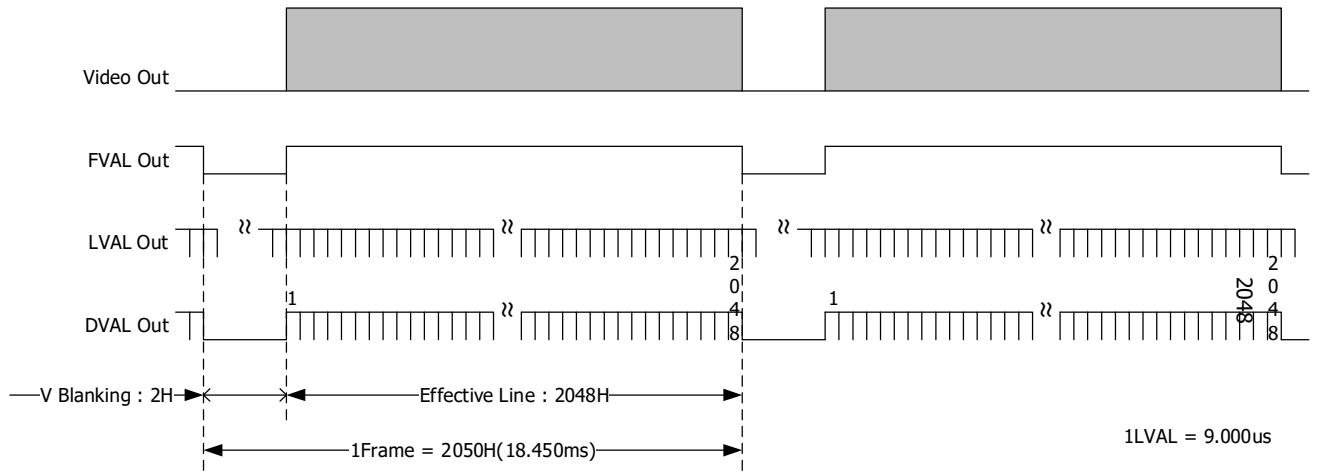

### 5.3. Horizontal Synchronous Signals Timing (4Tap Medium Configuration : HDR Mode)

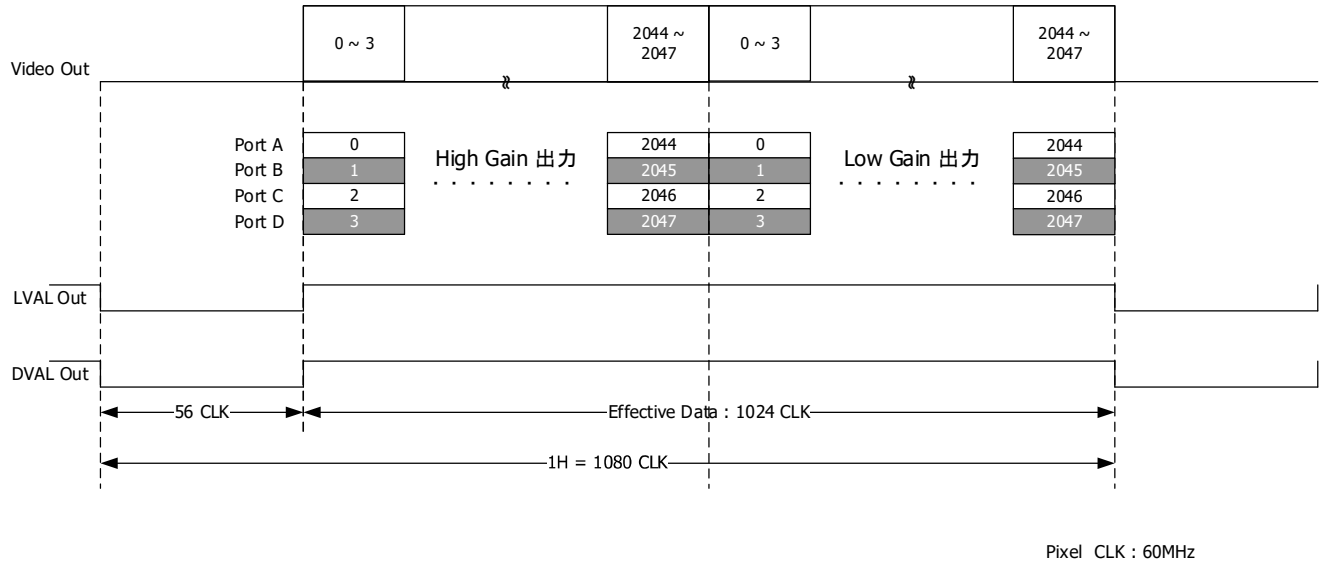

### 5.4. Vertical Synchronous Signals Timing (4Tap Medium Configuration : HDR Mode)

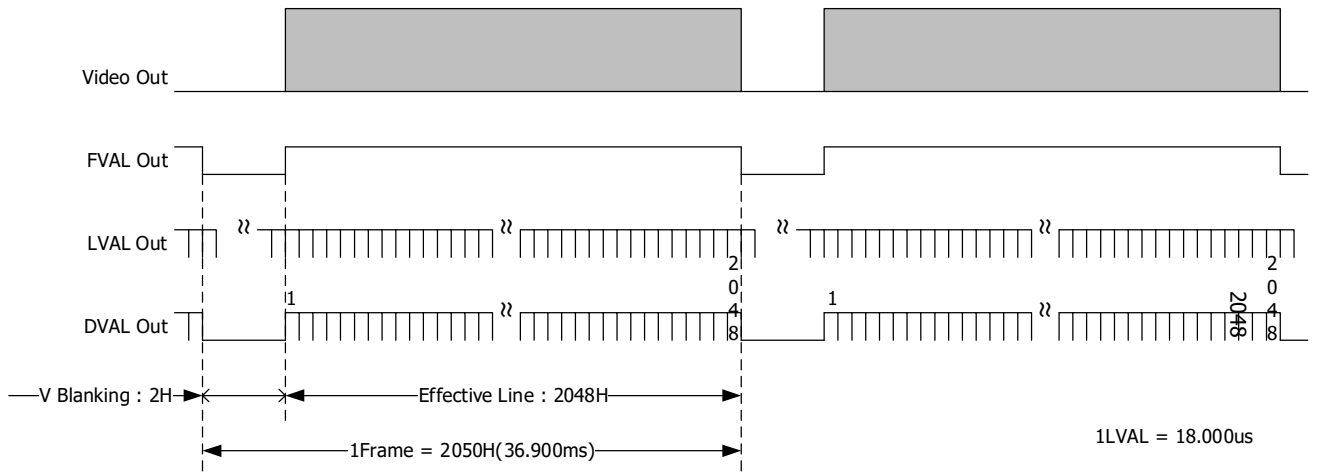

### 5.5. Horizontal Synchronous Signals Timing (2Tap Base Configuration : STD Mode)

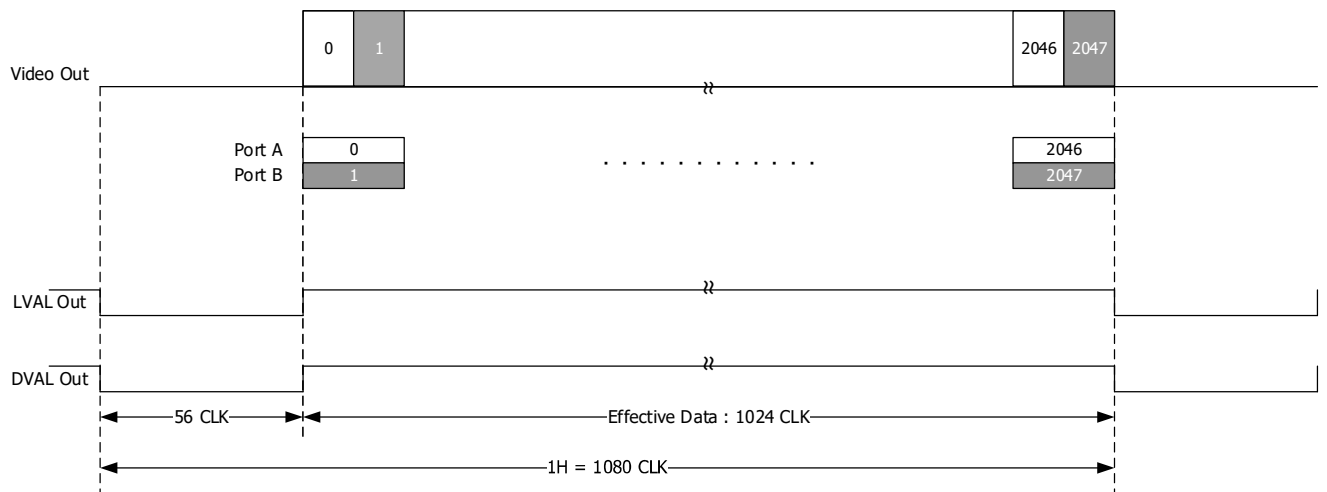

Pixel CLK : 60MHz

### 5.6. Vertical Synchronous Signals Timing (2Tap Base Configuration : STD Mode)

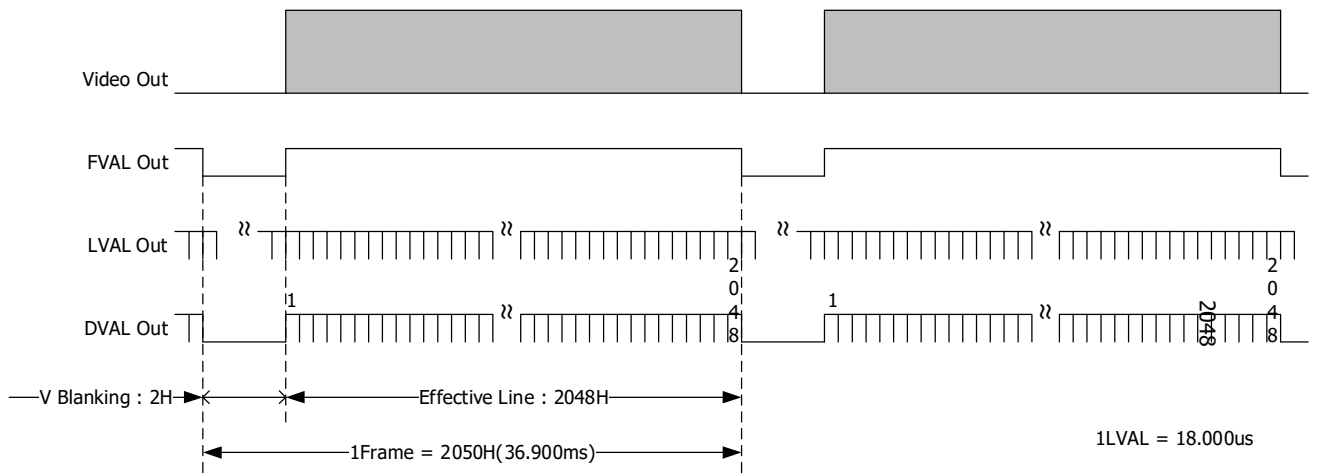

1LVAL = 18.000us

### 5.7. Horizontal Synchronous Signals Timing (2Tap Base Configuration : HDR Mode)

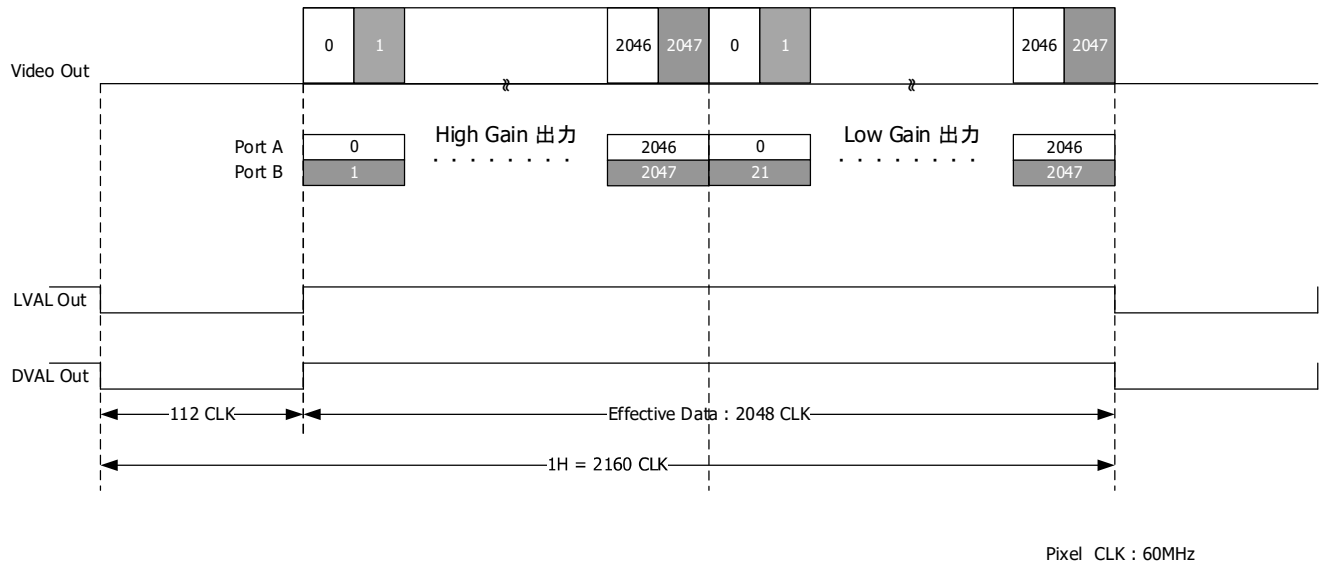

### 5.8. Vertical Synchronous Signals Timing (2Tap Base Configuration : HDR Mode)

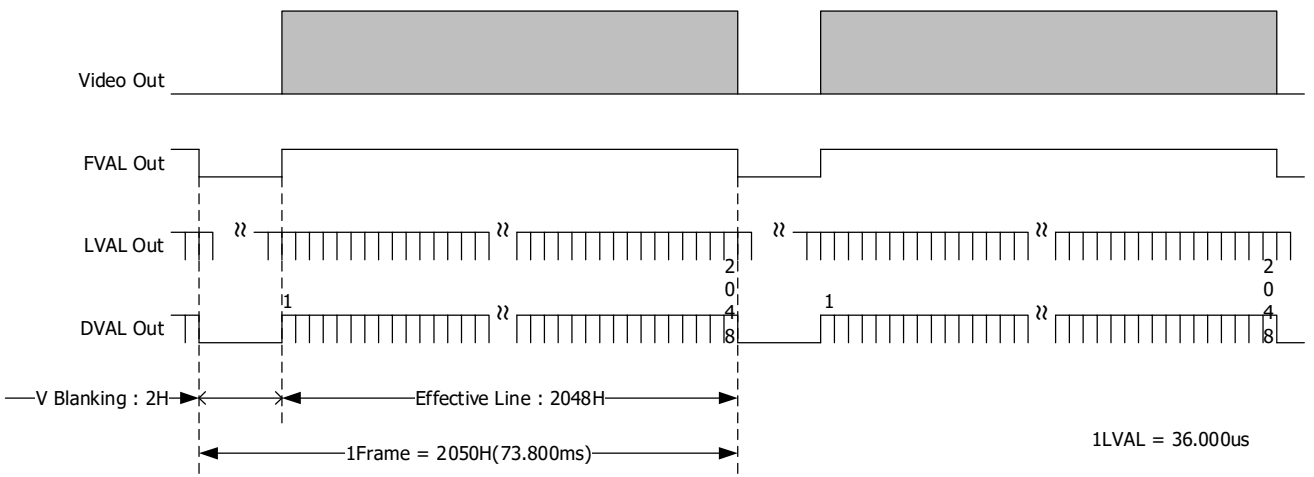

5.9. Video Output Format

(1) STD Mode (Medium Configuration 4Tap)

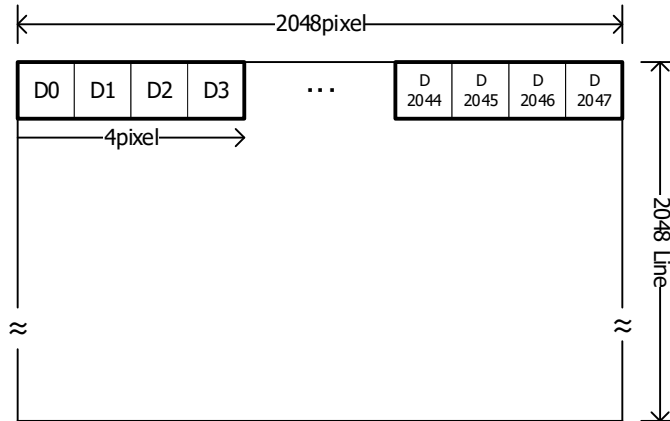

(2) HDR Mode (Medium Configuration 4Tap)

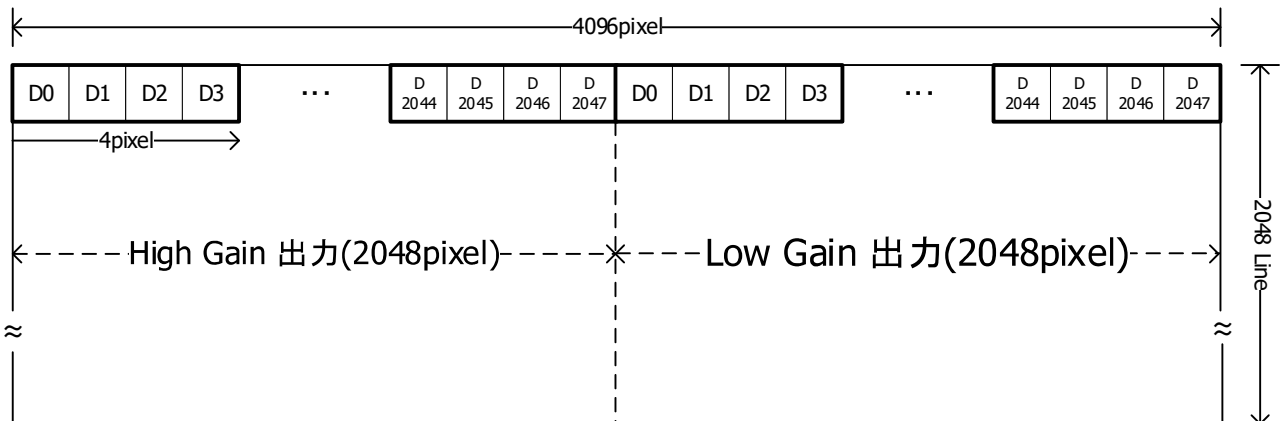

(3) STD Mode (Base Configuration 2Tap)

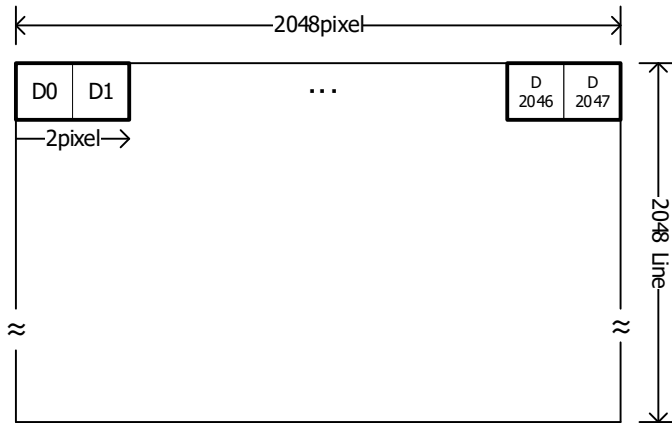

(4) HDR Mode (Base Configuration 2Tap)

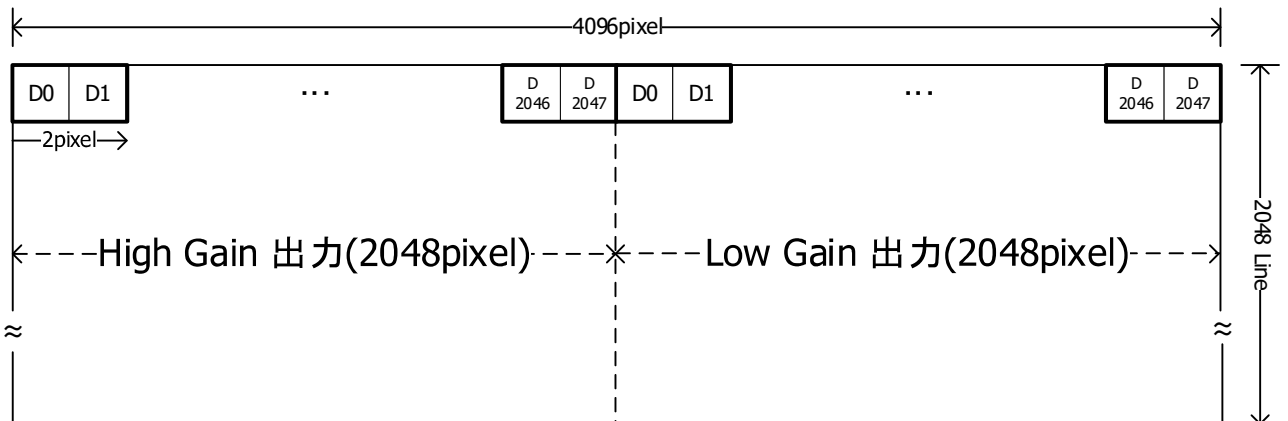

### 5.10. Fixed Trigger Shutter Mode

- This is the mode to start exposure with external input trigger signals, and set the exposure time with serial commands.
- Triggers can be accepted even when outputting video signals.  
However, trigger signals for exposure to start the next video output prior to the completion of video transmission for the prior video output signals can not be accepted.
- Trigger input during exposure time should be ignored. (Refer to the below A)

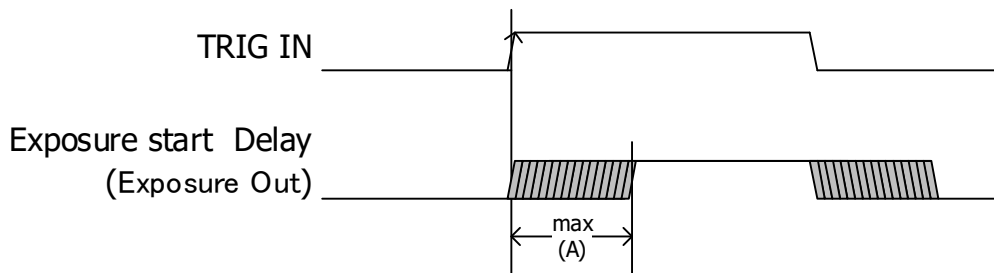

Exposure Start Delay : Medium Configuration 4Tap (A) max 18.100us

Exposure Start Delay : Base Configuration 2Tap (A) max 36.200us

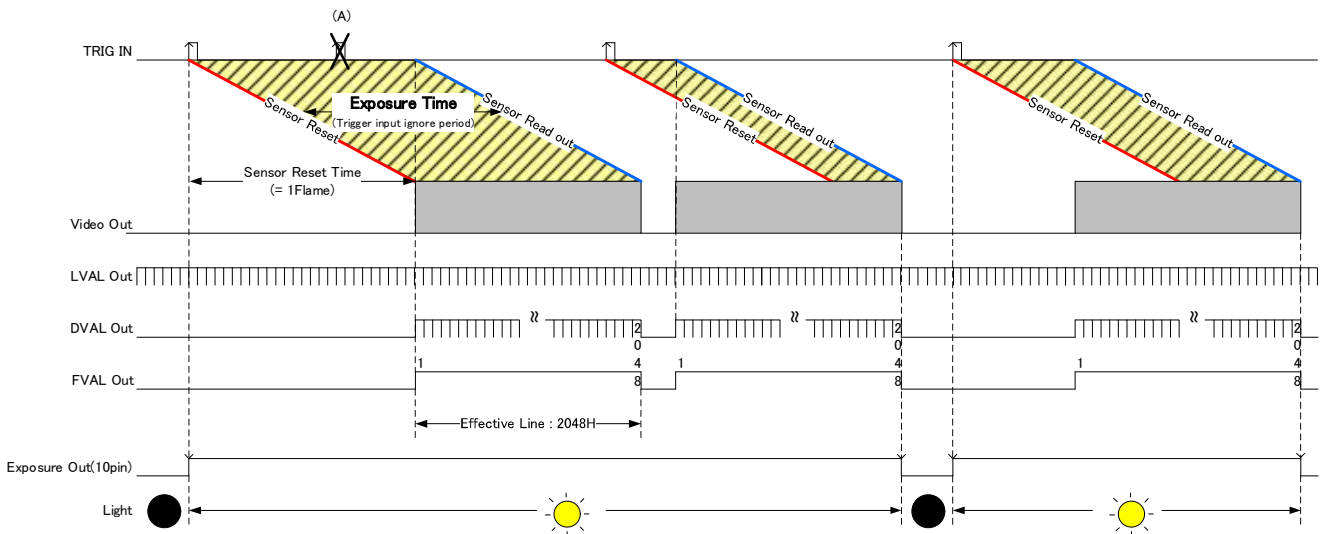

### 5.11. Pulse Width Trigger Shutter Mode

- This is the mode to start exposure with external input trigger signals, and set the exposure time with pulse width of the trigger signals.
- Pulse width is min. 1HD (min) to approx. 2 frames.  
Functionally, there is no upper limitation, but noises such as dark noises and shadings may be noticeable at long time exposure.
- Triggers can be accepted even when outputting video signals.  
However, trigger signals for exposure to start the next video output prior to the completion of video transmission for the prior video output signals can not be accepted.

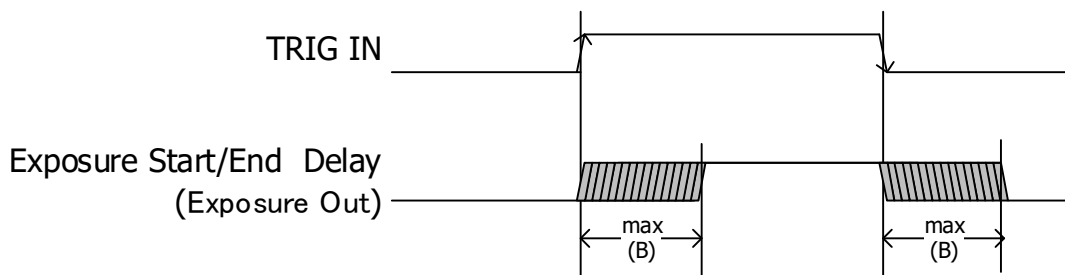

Exposure Start Delay : Medium Configuration 4Tap (B) max 18.100us

Exposure Start Delay : Base Configuration 2Tap (B) max 36.200us

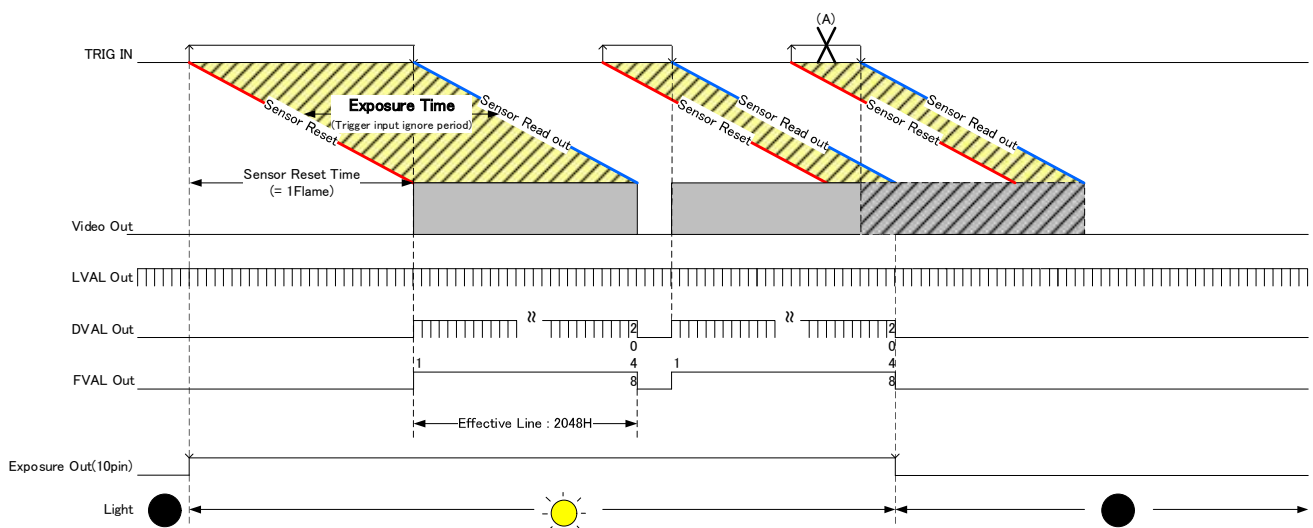



**6. Partial Scan Mode**

1 partial area can be set by serial commands.

Example : 1 partial area to be set.

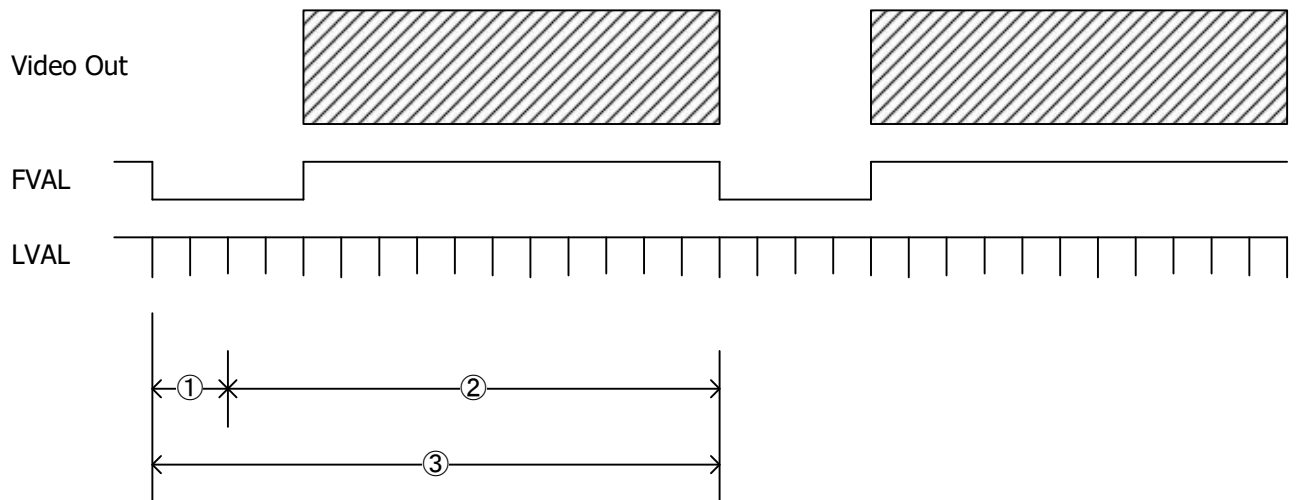

- ① : 2H fixed
- ② : Partial Area : 20H
- ③ : Total Frame line numbers : 22H(①+②)

Entire frame line numbers = **V blanking line numbers (2H fixed)** + Partial effective lines

Note that "Sum total of partial effective line numbers (except V blanking lines) < **2048**" should be met.

Frame rate =  $1 / (\text{Entire frame line numbers} \times \text{Time for 1 line})$

Camera Mode	Time for 1 Line
2Tap Base Configuration	18.000us(STD Mode)
	36.000us(HDR Mode)
4Tap Medium Configuration	9.000us(STD Mode)
	18.000us(HDR Mode)

Example

	Effective Line Number	Total Frame Number	Frame Rate (fps)			
			Medium Configuration 4Tap		Base Configuration 2Tap	
			STD Mode	HDR Mode	STD Mode	HDR Mode
2(min)	2H	4H	27777.8	13888.9	13888.9	6944.4
.	.					
VGA	480H	482H	230.5	115.3	115.3	57.6
.	.					
XGA	768H	770H	144.3	72.2	72.2	36.1
.	.					
SXGA	1024H	1026H	108.3	54.1	54.1	27.1
.	.					
UXGA	1200H	1202H	92.4	46.2	46.2	23.1
.	.					
2048 (Full)	2048H	2050H	54.2	27.1	27.1	13.6

## 7. Remote Communication

Via camera link cable, the camera can be controlled.

Communication Settings	
Baud Rate	: 115200bps (Fixed)
Data	: 8bit
Stop bit	: 1bit
Parity	: None
XON / XOFF	: No Control

- Send Command Format (Host to Camera)

If send a command, set the command and parameter between STX and ETX.

STX (02H)	command (2byte)	parameter (ASCII code) (20H-7FH)	ETX (03H)
--------------	--------------------	-------------------------------------	--------------

- Return Command Format (Camera to Host)

Normally, a camera returns a control code which is ACK or NAK.

If return value has a text message, the message is between STX and ETX.

ACK (06H)	... Succeed
--------------	-------------

NAK (15H)	... Fail
--------------	----------

STX (02H)	command (2byte)	parameter (ASCII code) (2FH- 7FH)	ETX (03H)	... return message
--------------	--------------------	--------------------------------------	--------------	--------------------

- Command List

Command	Function
SR	Set some values of resister
GR	Get some values of resister
SU	Set a user's data
GU	Get a user's data
CS	Save all configurations
CR	Restore all configurations
QM	Get a model name
QS	Get a serial number
QV	Get a firmware version
QE	Get a detail of error information

### 8.1. Command Specifications

- 1) Set some values of resister

**【Command】** Set : Resister

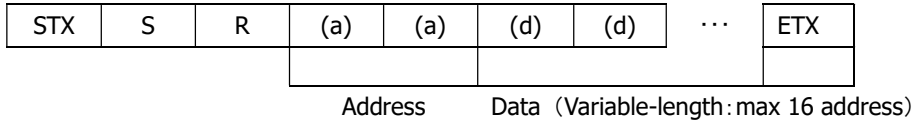

**【Return Value】**

Succeed	...	ACK
Fail	...	NAK

- 2) Get some value of resister

**【Command】** Get : Resister

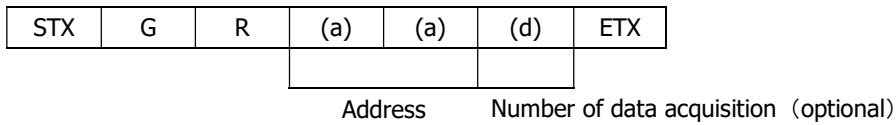

**【Return value】**

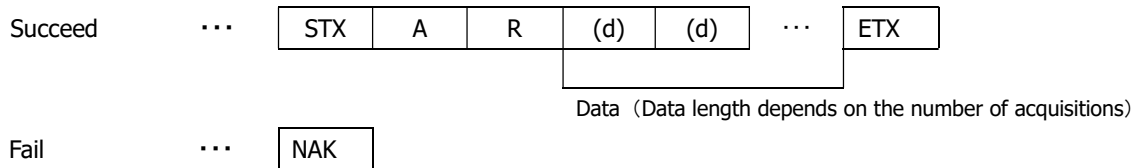

**【Remarks】**

The command gets some value of register of the specified address. The number of the acquisition is between '0' and 'F'( Hexadecimal ).  
 If appoint '0' at the address, the command send data of 16 address. If the command is omitted at the address, the command send an address.

### 3) Set User's data

【Command】 Set : User's data

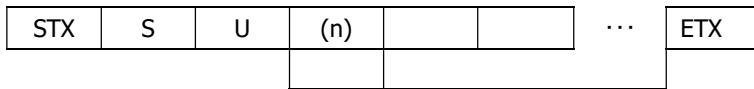

Table No.            User's data (fixed length :16byte)  
(0~3)

【Return Value】

Succeed	...	ACK
Fail	...	NAK

【Remarks】

The commands, sets free data on the specified register, and can use 4 tables (1 table : 16 characters).

### 4) Get User's data

【Command】 Get : User's data

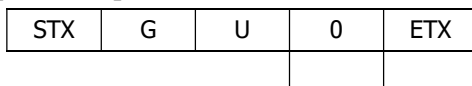
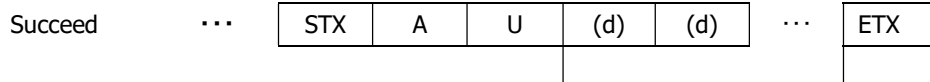

Table No.  
(0~3)

【Response】



User's data (fixed length : 16byte)

Fail	...	NAK
------	-----	-----

---

---

## 5) Save all configurations

【Command】 Configuration : Save

STX	C	S	ETX
-----	---	---	-----

【Return Value】

Succeed	...	ACK
Fail	...	NAK

## 6) Restore all configurations

【Command】 Configuration : Restore

STX	C	R	ETX
-----	---	---	-----

【Return Value】

Succeed	...	ACK
Fail	...	NAK

## 7) Get a model name

【Command】 Query : Model name

STX	Q	M	ETX
-----	---	---	-----

【Return Value】

Succeed	...	STX	R	M	(d)	(d)	...	ETX
					Model name (Fixed length: 16byte)			
Fail	...	NAK						

## 8) Get a serial number

【Command】 Query : Serial number

STX	Q	S	ETX
-----	---	---	-----

【Return Value】

Succeed	...	STX	R	S	(d)	(d)	...	ETX
					Serial Number(Fixed length: 8byte)			
Fail	...	NAK						

---

---

9) Get a firmware version

【Command】 Query : Version

STX	Q	V	ETX
-----	---	---	-----

【Return Value】

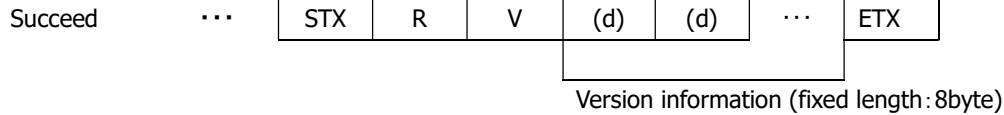

10) Get a detail of error information

【Command】 Query : Error

STX	Q	E	ETX
-----	---	---	-----

【Return Value】

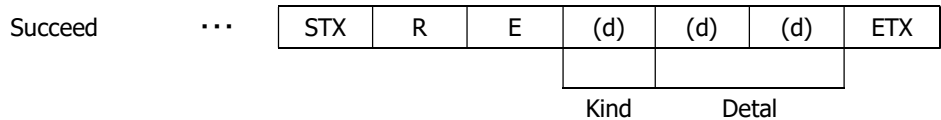

Kind	Detail
0: No Error	00: Normal result
1: Communication Protocol Error	00: The command is undefined.
	01: The command length is more than defined.
	02: The address is undefined.
	03: The value of data is undefined.
	04: The length is more than defined.
	05: The table number is undefined.
	06: The string of user data was abnormal.
2: Internal Control Error	00: Internal control is abnormal.
	01: A read only address was written by the command.
	02: A protected address was written by the command.
	03: Out of range address was written by the command.
	04: The selected table number is abnormal.
	05: The value of the man acquisition area is abnormal.
	06: A function is not implemented.

## 8.2. Control Example

1) How to check trigger shutter mode. ( The command gets a value from address 04)

【Send Command】

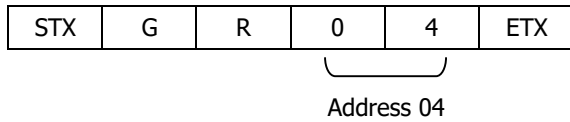

【Return value form camera】

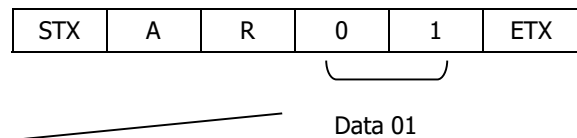

【Receive Return Value】

The camera is working with a trigger shutter mode, because the command received a 01 from the camera.

2) How to check trigger shutter mode. ( The command gets consecutive 2 bytes values from address 20)

【Send Command】

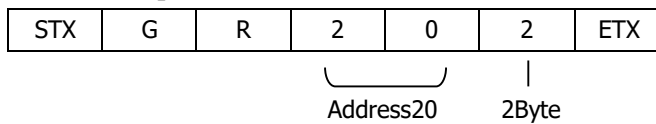

【Receive return value】

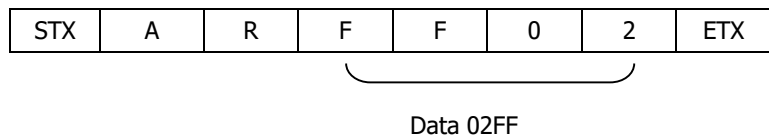

【Receive return value】

The shutter mode of camera is working +12dB, because the command received a 02FF(767) from the camera.



3) How to set partial scan mode. (The command sets 01 for address 08)

【Send Command】

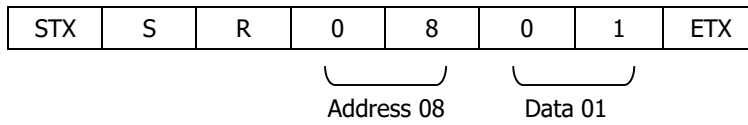

【Return value form camera】

ACK

【Receive Return Value】

The command finished normally, because the command received ACK from the camera.

4) How to set 01FF for manual shutter. (The command set 01FF for address 24)

【Send Command】



【Return value form camera】

ACK

【Receive Return Value】

The command finished normally, because the command received ACK from the camera.

---

---

5) How to save configurations of a camera. (The command send CS)

【Send Command】

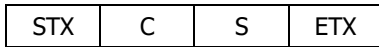

【Return value form camera】



【Receive Return Value】

The command finished normally, because the command received ACK from the camera.

6) How to restore the camera to initial settings. (The command send CR)

【Send Command】



【Return value form camera】



【Receive Return Value】

The command finished normally, because the command received ACK from the camera.

---

---

7) How to get detail of a communication error.

【Send Command】

STX	G	R	@	0	ETX
-----	---	---	---	---	-----

Set the address invalid value



【Return value form camera】

NAK
-----



【Receive return value】

The command finished abnormally, because the command received 'NAK' from the camera.  
When the command did not finish normally, retry to send command or send to get detail of a detail error command.

【Send Command】

STX	Q	E	ETX
-----	---	---	-----

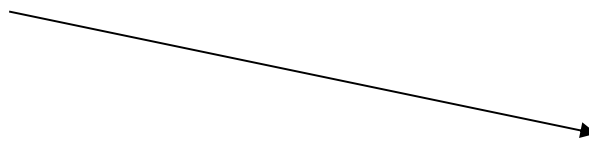

【Return value form camera】

STX	R	E	1	0	2	ETX
-----	---	---	---	---	---	-----

Kind1      Detail 02



【Receive Return Value】

The 'GR' command accessed invalid address , because the error command received kind '1' and detail '02'.

---

---

## 8. Function Setting

Function	Address(Hex)	Data(Hex)				
		Medium Configuration 4Tap		Base Configuration 2Tap		
		STD Mode	HDR Mode	STD Mode	HDR Mode	
Preset Shutter	01	00:	1/54.2s(OFF)	1/27.1s(OFF)	1/27.1s(OFF)	1/13.6s(OFF)
		01:	1/70s	1/35s	1/35s	1/18s
		02:	1/100s	1/50s	1/50s	1/25s
		03:	1/150s	1/70s	1/70s	1/38s
		04:	1/200s	1/100s	1/100s	1/50s
		05:	1/300s	1/150s	1/150s	1/75s
		06:	1/400s	1/200s	1/200s	1/100s
		07:	1/800s	1/400s	1/400s	1/200s
		08:	1/1500s	1/800s	1/800s	1/400s
		09:	1/3000s	1/1800s	1/1800s	1/900s
		0A:	1/6500s	1/3000s	1/3000s	1/1500s
		0B:	1/12000s	1/6500s	1/6500s	1/3250s
		0C:	1/20000s	1/12000s	1/12000s	1/6000s
		0D:	1/32000s	1/22000s	1/20000s	1/12000s
		0E:	1/32000s	1/38000s	1/22000s	1/22000s
				0F:	Manual (Address 24-25)	
Trigger Shutter Mode	04	00:	Normal (Trigger OFF)			
		01:	Fixed Trigger Shutter Mode(Address 01)			
		02:	Pulse width Trigger Shutter Mode			
Polarity	05	00:	Positive			
		01:	Negative			
Trigger input	06	00:	CC1			
		01:	12pin connector 11pin input			
Partial Scan Mode	08	00:	Full frame			
		01:	Partial scan			
CL Output Mode	0A	00:	Medium Configuration 4Tap			
		01:	Base Configuration 2Tap			
Output Mode	0B	00:	8bit			
		01:	10bit			
		02:	12bit			

Function	Address(Hex)	Data(Hex)	
Camera output position setting STD Mode Low Gain output / HDR Mode Low Gain output Effect to image	14	00:	12bit data B11 : B0 output
		01:	12bit data B10 : B0+'0' output
		02:	12bit data B9 : B0+'00' output
		03:	12bit data B8 : B0+'000' output
		04:	12bit data B7 : B0+'0000' output
Camera output position setting STD Mode High Gain output / HDR Mode High Gain output Effect to image	15	00:	12bit data B11 : B0 output
		01:	12bit data B10 : B0+' 0' output
		02:	12bit data B9 : B0+' 00' output
		03:	12bit data B8 : B0+' 000' output
		04:	12bit data B7 : B0+' 0000' output
Flip (flip upside down)	18	00:	OFF
		01:	ON
LED ON/OFF	1B	00:	OFF
		01:	ON
Sensor Mode	1C	00:	STD Mode Low Gain output
		01:	STD Mode High Gain output
		02:	HDR Mode
Manual Gain	20-21	LLHH:	min:0(0000H) - max:7935(1EFFH) min 0= x1(0dB), 256= x2(6dB), 768= x4(+12dB), 1792= x8(18dB), 3840= x16(+24dB)
Manual Shutter	24-25	LLHH:	min:0(0000H) - max:2047(7FFH) Exposure time(Medium Configuration 4Tap, STD Mode) = 13.333us + (1024 - (Setting value/2 ※))×18.000us ※ Setting value/2 : Decimal point truncation min:0=18.445ms, max:2047=31.333us
			min:0(0000H) - max:2047(7FFH) Exposure time(Medium Configuration 4Tap, HDR Mode) = 8.316us + (2048 - (setting value))×18.000us min:0=36.872ms, max:2047=26.316us
			min:0(0000H) - max:2047(7FFH) Exposure time(Base Configuration 2Tap, STD Mode) = 13.333us + (1024 - (setting value/2 ※))×36.000us ※ Setting value/2 : Decimal point truncation min:0=36.877ms, max:2047=49.333us
			min:0(0000H) - max:2047(7FFH) Exposure time(Base Configuration 2Tap, HDR Mode) = 8.316us + (2048 - (setting value))×36.000us min:0=73.736ms, max:2047=44.316us

Function	Address(Hex)	Data(Hex)	
Read temperature of CMOS sensor board part (Read Only)	2E	LL:	max +150° : 150(96H) 0° : 0(00H) min - 55° : 201(C9H)
Read temperature of FPGA board part (Read Only)	2F	LL:	max +150° : 150(96H) 0° : 0(00H) min - 55° : 201(C9H)
STD Mode Low Gain output / HDR Mode Low Gain output CMOS sensor gain register	36	00:	0.66 x
		01:	1.85 x
		02:	2.49 x
		03:	3.68 x
		04:	1.29 x
		05:	3.70 x
		06:	4.95 x
		07:	7.25 x
STD Mode High Gain output / HDR Mode High Gain output CMOS sensor gain register	37	00:	0.66 x
		01:	1.85 x
		02:	2.49 x
		03:	3.68 x
		04:	1.29 x
		05:	3.70 x
		06:	4.95 x
		07:	7.25 x
Set-up Level register	38-39	LLHH:	Under 02h (Factory setting)
Partial Scan Start Position	40-41	LLHH:	Full frame scan Mode : 0(0000H) min:0(0000H) - max:2046(07FEH)
Partial Scan Effective line number	50-51	LLHH:	Full frame scan Mode : 2048(0800H) min:2(0002H) - max:2048(0800H)

※ The data set with 1 Byte

< Example > Trigger Mode (Address 04) ->02(02H)

STX SR 04 2 ETX

※ LLHH : The data set with 2 Byte shall be set with Low Byte first, then set with High Byte.

< Example > Manual Shutter (Address 24-25) ->6671(1A0FH)

STX SR 24 0F 1A ETX

9. Dimensions

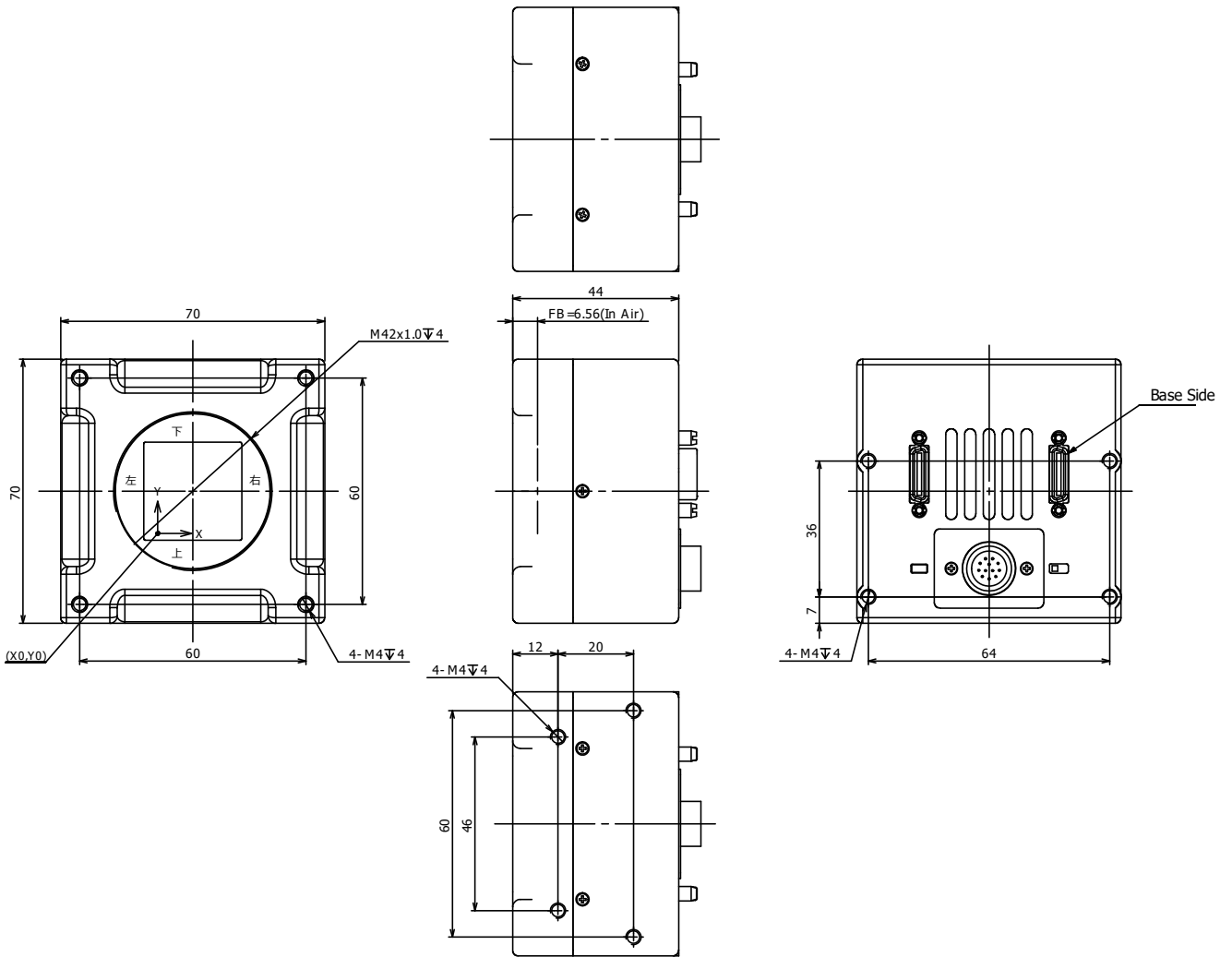

**10. Initial Setting**

Function	Address(Hex)	Data(Hex)	
Shutter	01	00:	1/54.2s(OFF)
Trigger shutter Mode	04	00:	Normal(Trigger OFF)
Trigger polarity	05	00:	Positive
Trigger input	06	00:	CC1
Partial scan Mode	08	00:	Full frame
Camera output Mode	0A	00:	Medium Configuration 4Tap
Camera Link output	0B	00:	8bit
Camera output bit position	14	00:	12bit data B11:B0 output
Camera output bit position	15	00:	12bit data B11:B0 output
Flip	18	00:	OFF
LED ON/OFF	1B	01:	ON
Sensor Mode	1C	00:	STD Mode Low Gain output
Manual Gain	20-21	0000:	0dB
Manual Shutter	24-25	0000:	shutter(OFF)
Low Gain CMOS sensor gain register	36	03:	3.68 x
High Gain CMOS sensor gain register	37	03:	3.68 x
Partial scan start position	40-41	0000:	Start position
Partial scan effective line number	50-51	0800:	Effective Line number 2048



#### 11. Cases for Indemnity (Limited Warranty)

We shall be exempted from taking responsibility and held harmless for damage or losses incurred by the user in the following cases.

- In case damage or losses are caused by fire, earthquake, or other acts of God, acts by third party, deliberate or accidental misuse by the user, or use under extreme operating conditions.
- In case indirect, additional, consequential damages (loss of business interests, suspension of business activities) are incurred as result of malfunction or non-function of the equipment, we shall be exempted from responsibility for such damages.
- In case damage or losses are caused by failure to observe the information contained in the instructions in this product specification & operation manual.
- In case damage or losses are caused by use contrary to the instructions in this product specification & operation manual.
- In case damage or losses are caused by malfunction or other problems resulting from use of equipment or software that is not specified.
- In case damage or losses are caused by repair or modification conducted by the customer or any unauthorized third party (such as an unauthorized service representative).

#### 12. CMOS Pixel Defect

IDULE compensates the noticeable CMOS pixel defects found at the shipping inspection prior to our shipment. On very rare occasions, however, CMOS pixel defects might be noted with time of usage of the products.

Cause of the CMOS pixel defects is the characteristic phenomenon of CMOS itself and IDULE is exempted from taking any responsibilities for them. Should you have any questions on CMOS pixel defects compensation, please contact us.

#### 13. Product Support

When defects or malfunction of our products occur, and if you would like us to investigate on the cause and repair, please contact your distributors you purchased from to consult and coordinate.

---

---